

Weld & Metal Face Seal Fittings



Weld & Metal Face Seal Fittings

CONTENTS

Features	256	Typical Assemblies	258
Internal Surface Finish Levels	256	Installation Instruction	258
Materials	257	How To Order	259
Pressure-Temperature Ratings	257	Weld Fittings	260
Test	257	Metal Face Seal Fittings	264
Cleaning & Packaging	257		

Weld Fittings



CME ²⁶⁰
Micro Elbow 90°



CMRE ²⁶⁰
Reducing Micro Elbow 90°



CMVE ²⁶⁰
Micro Elbow 45°



CMT ²⁶⁰
Micro Tee



CMRT ²⁶¹
Reducing Micro Tee



CMTB ²⁶¹
Micro Tribow



CMC ²⁶¹
Micro Cross



CMRU ²⁶¹
Reducing Micro Union



CLE ²⁶²
Long Elbow 90°



CLRE ²⁶²
Reducing Long Elbow 90°



CLT ²⁶²
Long Tee



CLRT ²⁶³
Reducing Long Tee



CLRU ²⁶³
Reducing Long Union

Metal Face Seal (UCR) Fittings Glands



CMGS ²⁶⁴
Micro Gland S



CMGL ²⁶⁴
Micro Gland L



CSGS ²⁶⁴
Short Gland S



CSGL ²⁶⁴
Short Gland L



CLGS ²⁶⁵
Long Gland S



CLGL ²⁶⁵
Long Gland L



CSGWS ²⁶⁶
Socket Weld Short Gland



CLGWS ²⁶⁶
Socket Weld Long Gland



CLGRWS ²⁶⁶
Reducing Socket Weld Long Gland



CBG ²⁶⁶
Blind Gland

Metal Face Seal (UCR) Fittings Caps, Plugs, Nuts & Gaskets



CCP ²⁶⁷
UCR Cap



CPG ²⁶⁷
UCR Plug



CFN ²⁶⁷
UCR Female Nut



CMN ²⁶⁷
UCR Male Nut



CGT ²⁶⁸
UCR Gasket



CGTR ²⁶⁸
UCR Gasket Retained



CGTB ²⁶⁸
UCR Gasket Blind

Metal Face Seal (UCR) Fittings High Flow Components



CHG ²⁶⁹
HR Gland



CHA ²⁶⁹
HR Adapter



CHBA ²⁶⁹
HR Bulkhead Adapter



CHFN ²⁶⁹
HR Female Nut



CHMN ²⁶⁹
HR Male Nut

UCR Threaded Fittings UCR to UCR



CDMU ²⁷⁰
Double Male Union



CDMRU ²⁷⁰
Reducing Double Male Union



CBDMU ²⁷⁰
Bulkhead Double Male Union



CEU ²⁷⁰
Union Elbow



CUT ²⁷¹
Union Tee



CUC ²⁷¹
Union Cross



CDFRU ²⁷¹
Reducing Double Female Union



CRA ²⁷¹
Reducing Adapter



CRB ²⁷²
Reducing Bushing



CC ²⁷²
Coupling

UCR Threaded Fittings UCR to TBW



CAWB ²⁷³
TBW Adapter



CBAWB ²⁷³
Bulkhead TBW Adapter

UCR Threaded Fittings UCR to UNILOK



CULC ²⁷³
UNILOK Connector



CBULC ²⁷³
Bulkhead UNILOK Connector

UCR Threaded Fittings UCR to Thread



CUMC ²⁷⁴
Male Connector



CUME ²⁷⁴
Male Elbow



CUFC ²⁷⁴
Female Connector

UNILOK® Weld & Metal Face Seal (UCR) fittings are designed and manufactured as high performance and high purity components by our own know-how to be accumulated throughout the years. UNILOK® guarantees high quality butt welding between tube and fittings as well as leak free assembly for critical applications.

Features

Metal Face Seal (UCR) Fittings

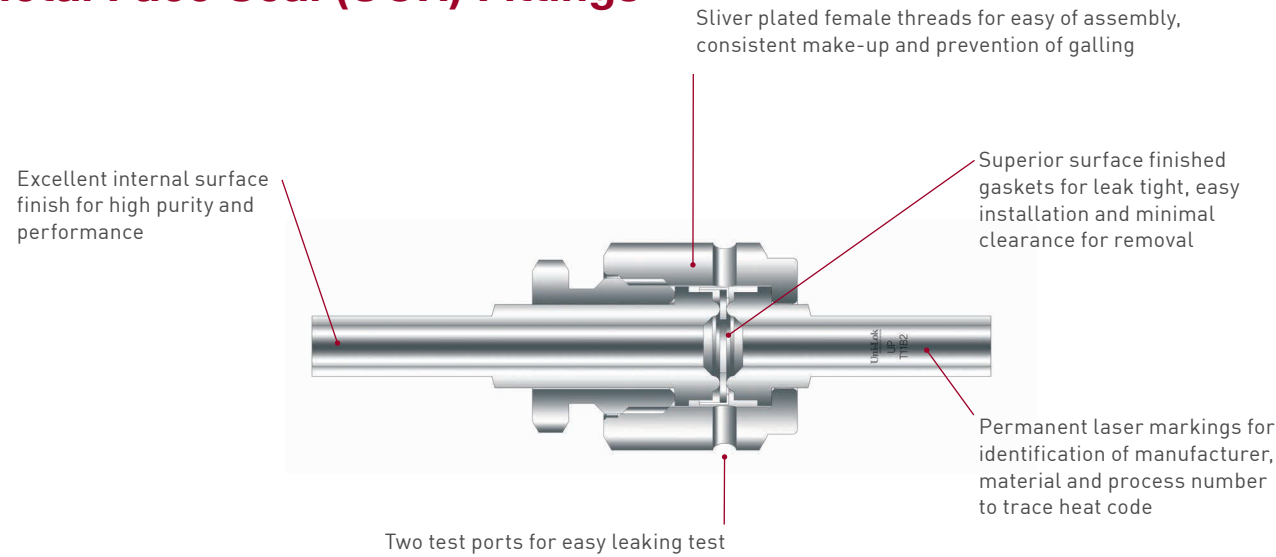

Weld Fittings

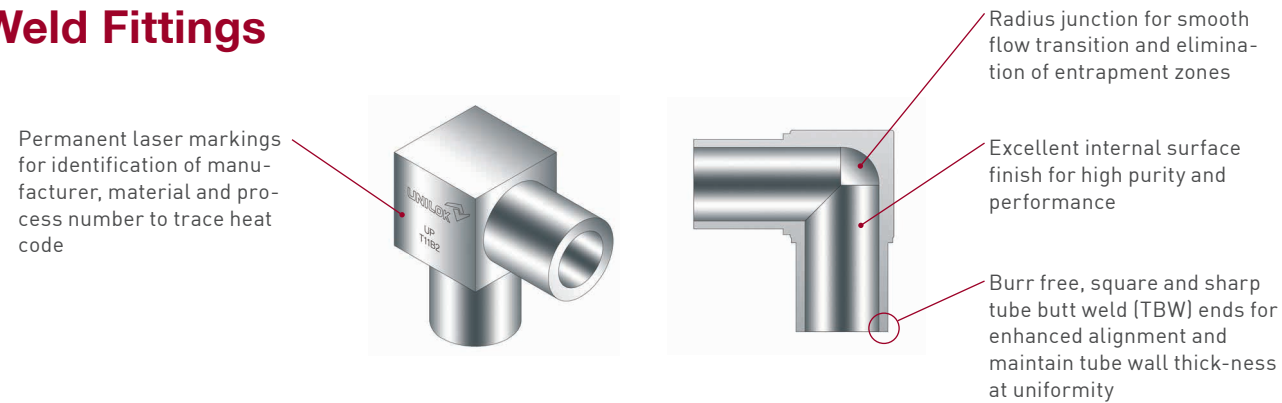

Internal Surface Finish Levels

Designator	Surface Finish(μm)	
	Average	Maximum
BA	< 0.4	< 1.6
EP	< 0.125	< 0.4

Reference Specification :
SEMA-90120400B

Surface Analysis

SEM, ESCA/XPS, AES analysis for all electro polished products are used to measure surface cleanliness and anticorrosion requirements in accordance with SEMA specifications.
SEM - SEMA 90120401B-STD
ESCA/XPS - SEMA 90120403B-STD
AES - SEMA 91060573B-STD

Plating

Female nuts are silver plated for easy of assembly, consistent make-up, prevention of galling and reduction of the torque required for fitting assembling.

Materials

Materials	Specification
Glands, Unions, Weld Fittings	
VIM/VAR	Forging - ASTM A182 Bar Stock - ASTM SA479
VCR/VAR	
316LSS	
Nuts, Plugs, Caps, UCR Threaded Fittings	
316LSS	Forging - ASTM A182 Bar Stock - ASTM SA479
Gaskets	
Nickel	ASTM B162
316LSS	ASTM A167

Both VCR/VAR and 316LSS are UHP(Ultra High Purity) 316LSS material with low Sulfur and Manganese in comply with SEMI F-20.

Pressure Ratings

Tube O.D.	Wall Thickness	Pressure Rating	
		psig	bar
1/4"	1.00mm	5200	359
	0.89mm		
3/8"	1.00mm	3350	231
	0.89mm		
1/2"	1.24mm	3750	259
3/4"	1.65mm	3350	231
1"	1.65mm	2400	265

0.89mm(0.035") wall thick fittings are available upon request. When ordering, be sure to add -A to the part number.

Pressure ratings are calculated in accordance with ANSI/ASME B31.3 for stainless steel pressure piping at room temperature.

Temperature Ratings

Components	Materials	°F	°C
Fittings	VIM/VAR	1000	537
	VCR/VAR		
	316LSS		
Gaskets	316LSS	1000	537
	Nickel	600	315

Helium Leak Test

UNILOK fittings are rated to a helium leak rate of less than 1x10⁻⁹ mbar.l/sec and tested in accordance with SEMA-90120391B-STD and SEMI F1-96.

Particle Contribution Test

According to ASTM F1394-92.

Moisture Contribution Test

According to SEMA-90120397B-STD.

Cleaning

All components are precisely cleaned with 18MΩ deionized water after the passivation procedure. Reference specification : SEMI E49.6.

Assembling

According to SEMI E49.6.

Packaging

Each component is double bagged to ensure component cleanliness and to protect them from environmental contamination. Referenced specification : SEMI E49.1.

Typical Assemblies

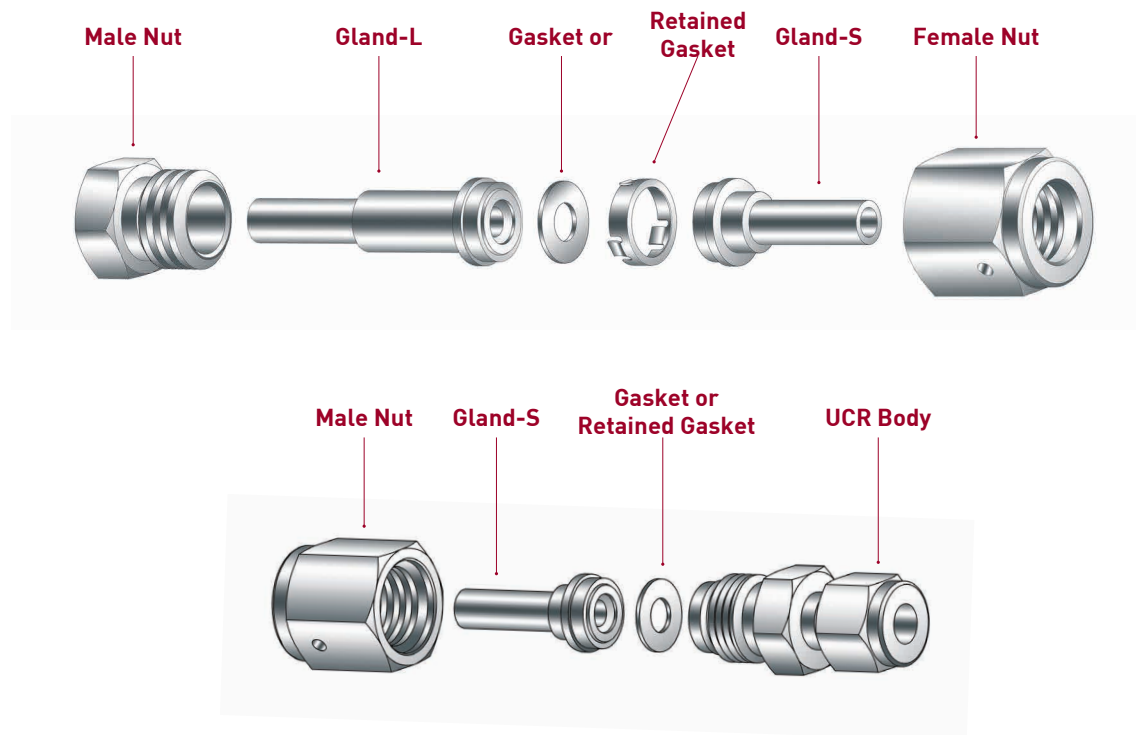

Installation Instruction



Step A.
Place gasket into female nut.



Step C.
Tighten female nut 1/8 turn past finger tight holding the backup wrench stationary.



Step AA.
Guide retained gasket over gland UCR face.



Step D.
Confirm face seal and gasket's position again.



Step B.
Tighten female nut to male nut or UCR body finger tight.

Metal face seal connections are remakeable only using new gasket for each remake.

How To order

UNILOK weld fittings are ordered by part number as shown below.

Example: The following part number, *CLGS-0804-SM-EP* is designated for Long Gland S, 1/2"UCR x 1/4"TBW", Single Melting 316LSS, EP.

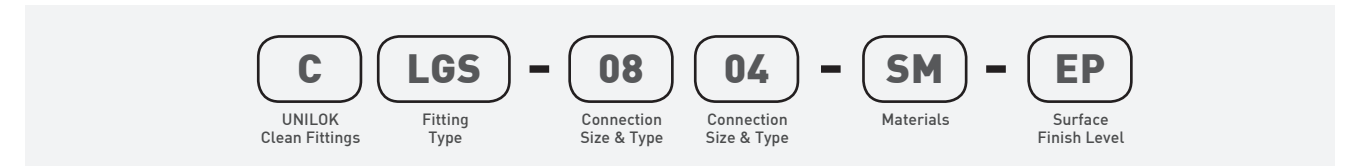

Connection Size & Type							
Fractional(Inch) Tube O.D. Designation							
Tube O.D.	inch	1/8	1/4	3/8	1/2	3/4	1
	mm	3.17	6.35	9.52	12.70	19.05	25.40
Designator		02	04	06	08	12	16

Materials	
DM	316LSS - Double Melting
SM	316LSS - Single Melting
SL	316LSS
NI	Nickel

UCR (Metal Face Seal) Size Designator				
Pipe Size	1/4	1/2	3/4	1
Designator	04	08	12	16

Surface Finish Level	
BA	BA - Bright Annealing
EP	EP - Electro Polished

Pipe Size Designation (NPT or ISO7/1(PT))					
Pipe Size	1/4	3/8	1/2	3/4	1
Designator	04N/R	06N/R	08N/R	12N/R	16N/R

CME
Micro Elbow 90°

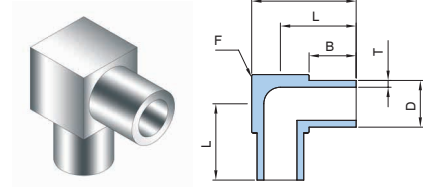

Part No.	Tube O.D. D		Tube W.T. T		Dimension (mm)				Body Cube
	inch	mm	inch	mm	A	B	L	F	
CME-02-	1/8	3.17	0.028	0.71	14.29	6.35	10.32	7.94	
CME-04-*A	1/4	6.35	0.035	0.89					
CME-04-	1/4	6.35	0.039	1.00	17.46	6.35	11.91	11.11	
CME-06-	3/8	9.52		1.00			17.46	11.91	11.11
CME-08-	1/2	12.70	0.049	1.24	20.64	6.35	13.50	14.29	
CME-12-	3/4	19.05	0.065	1.65	27.00	6.35	16.67	20.65	

CMRT
Reducing Micro Tee

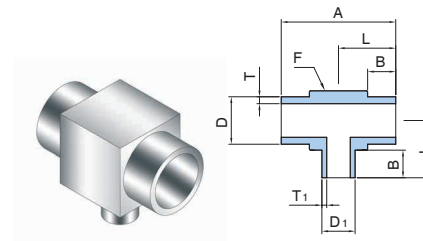

Part No.	Tube O.D. D		Tube W.T. T		Tube O.D. D ₁		Tube W.T. T ₁		Dimension (mm)				Body Cube
	inch	mm	inch	mm	inch	mm	inch	mm	A	B	L	F	
CMRT-0402-	1/4	6.35	0.039	1.00	1/8	3.17	0.028	0.71	20.64	6.35	10.32	7.94	
CMRT-0604-	3/8	9.52		1.00	1/4	6.35	1.00	23.81	10.32		11.11		
CMRT-0804-	1/2	12.70	0.049	1.24	1/4	6.35	0.039	1.00	26.99	6.35	13.50	14.29	
CMRT-0806-	1/2	12.70	0.049	1.24	3/8	9.52		1.00			14.29		

CMRE
Reducing Micro Elbow 90°

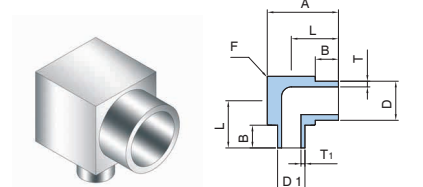

Part No.	Tube O.D. D		Tube W.T. T		Tube O.D. D ₁		Tube W.T. T ₁		Dimension (mm)				Body Cube
	inch	mm	inch	mm	inch	mm	inch	mm	A	B	L	F	
CMRE-0402-	1/4	6.35	0.039	1.00	1/8	3.17	0.028	0.71	14.29	6.35	10.32	7.94	
CMRE-0604-	3/8	9.52		1.00	1/4	6.35	1.00	17.46	10.32		11.11		
CMRE-0804-	1/2	12.70	0.049	1.24	1/4	6.35	0.039	1.00	20.64	6.35	13.50	14.29	
CMRE-0806-	1/2	12.70	0.049	1.24	3/8	9.52		1.00			14.29		

CMTB
Micro Tribow

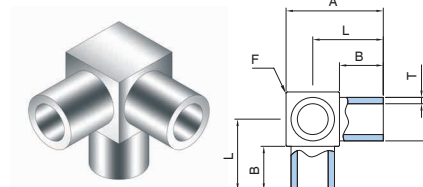

Part No.	Tube O.D. D		Tube W.T. T		Dimension (mm)			Body Cube
	inch	mm	inch	mm	B	L	F	
CMTB-04-*A-	1/4	6.35	0.035	0.89	6.35	10.32	7.94	
CMTB-04-	1/4	6.35	0.039	1.00				
CMTB-06-	3/8	9.52		1.00				
CMTB-08-	1/2	12.70	0.049	1.24				13.50

CMVE
Micro Elbow 45°

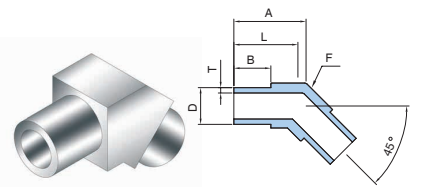

Part No.	Tube O.D. D		Tube W.T. T		Dimension (mm)				Body Cube
	inch	mm	inch	mm	A	B	L	F	
CMVE-04-*A-	1/4	6.35	0.035	0.89	11.96	6.35	10.32	7.94	
CMVE-04-	1/4	6.35	0.039	1.00					
CMVE-06-	3/8	9.52		1.00	14.21	17.46	6.35	11.91	11.11
CMVE-08-	1/2	12.70	0.049	1.24	16.46			13.50	14.29

CMC
Micro Cross

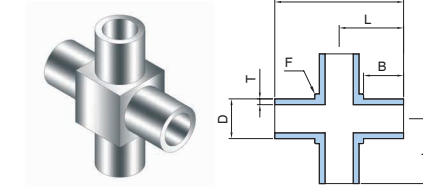

Part No.	Tube O.D. D		Tube W.T. T		Dimension (mm)				Body Cube
	inch	mm	inch	mm	A	B	L	F	
CMC-04-*A-	1/4	6.35	0.035	0.89	20.64	6.35	10.32	7.94	
CMC-04-	1/4	6.35	0.039	1.00					
CMC-06-	3/8	9.52		1.00	23.81	26.99	6.35	11.91	11.11
CMC-08-	1/2	12.70	0.049	1.24	26.99			13.50	14.29

CMT
Micro Tee

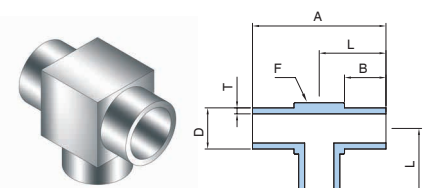

Part No.	Tube O.D. D		Tube W.T. T		Dimension (mm)				Body Cube
	inch	mm	inch	mm	A	B	L	F	
CMT-02-	1/8	3.17	0.028	0.71	20.64	6.35	10.32	7.94	
CMT-04-*A	1/4	6.35	0.035	0.89					
CMT-04-	1/4	6.35	0.039	1.00	23.81	6.35	11.91	11.11	
CMT-06-	3/8	9.52		1.00			23.81	11.91	11.11
CMT-08-	1/2	12.70	0.049	1.24	26.99	6.35	13.50	14.29	
CMT-12-	3/4	19.05	0.065	1.65	33.35	6.35	16.67	20.65	

CMRU
Reducing Micro Union

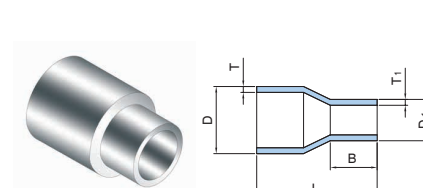

Part No.	Tube O.D. D		Tube W.T. T		Tube O.D. D ₁		Tube W.T. T ₁		Dimension (mm)	
	inch	mm	inch	mm	inch	mm	inch	mm	B	L
CMRU-0402-	1/4	6.35	0.039	1.00	1/8	3.17	0.028	0.71	6.35	19.05
CMRU-0604-	3/8	9.52		1.00	1/4	6.35	1.00			
CMRU-0804-	1/2	12.70	0.049	1.24	1/4	6.35	0.039	1.00		
CMRU-0806-	1/2	12.70	0.049	1.24	3/8	9.52		1.00		
CMRU-1204-	3/4	19.05	0.065	1.65	1/4	6.35	1.00	1.00		
CMRU-1206-	3/4	19.05	0.065	1.65	3/8	9.52	1.00	1.00		
CMRU-1208-	3/4	19.05	0.065	1.65	1/2	12.70	0.049	1.24		

Dimensions are for reference only and are subject to change without prior notice.

Dimensions are for reference only and are subject to change without prior notice.

CLE Long Elbow 90°

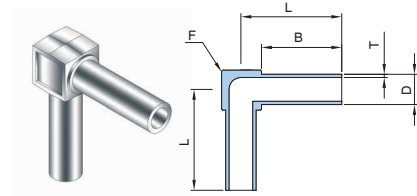

Part No.	Tube O.D. D		Tube W.T. T		Dimension (mm)			Body Cube
	inch	mm	inch	mm	B	L	F	
CLE-04-	1/4	6.35	0.039	1.00	19.00	20.00	25.00	9.00
CLE-06-	3/8	9.52		1.00			11.00	
CLE-08-	1/2	12.7	0.049	1.24		27.00	15.00	
CLE-12-	3/4	19.05	0.065	1.65		31.50	22.00	
CLE-16-	1	25.4	0.049	1.65		34.00	30.00	

CLRT Reducing Long Tee

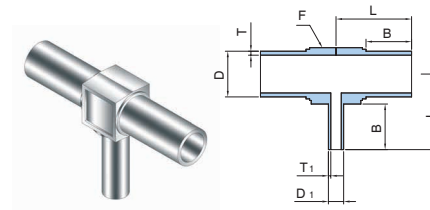

Part No.	Tube O.D. D		Tube W.T. T		Tube O.D. D ₁		Tube W.T. T ₁		Dimension (mm)			Body Cube
	inch	mm	inch	mm	inch	mm	inch	mm	B	L	F	
CLRT-0604-	3/8	9.52	0.039	1.00	1/4	6.35	0.039	1.00	19.00	25.00	11.00	
CLRT-0804-	1/2	12.70	0.049	1.24	1/4	6.35		1.00				
CLRT-0806-	1/2	12.70	0.049	1.24	3/8	9.52		1.00		27.00	15.00	
CLRT-1204-	3/4	19.05	0.065	1.65	1/4	6.35		1.00		31.50	22.00	
CLRT-1206-	3/4	19.05	0.065	1.65	3/8	9.52		1.00				
CLRT-1208-	3/4	19.05	0.065	1.65	1/2	12.70	0.049	1.24				

CLRE Reducing Long Elbow 90°

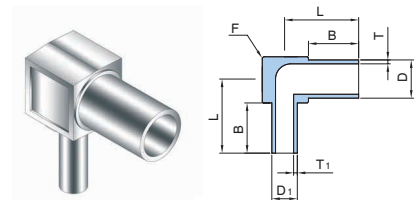

Part No.	Tube O.D. D		Tube W.T. T		Tube O.D. D ₁		Tube W.T. T ₁		Dimension (mm)			Body Cube
	inch	mm	inch	mm	inch	mm	inch	mm	B	L	F	
CLRE-0604-	3/8	9.52	0.039	1.00	1/4	6.35	0.039	1.00	19.00	25.00	11.00	
CLRE-0804-	1/2	12.70	0.049	1.24	1/4	6.35		1.00				
CLRE-0806-	1/2	12.70	0.049	1.24	3/8	9.53		1.00		27.00	15.00	
CLRE-1204-	3/4	19.05	0.065	1.65	1/4	6.35		1.00		31.50	22.00	
CLRE-1206-	3/4	19.05	0.065	1.65	3/8	9.52		1.00				
CLRE-1208-	3/4	19.05	0.065	1.65	1/2	12.70	0.049	1.24				

CLRU Reducing Long Union

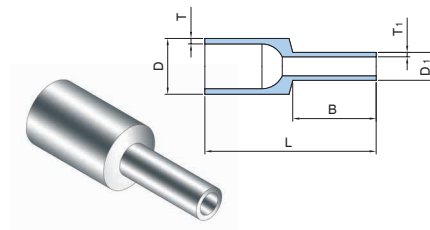

Part No.	Tube O.D. D		Tube W.T. T		Tube O.D. D ₁		Tube W.T. T ₁		Dimension (mm)			Body Cube
	inch	mm	inch	mm	inch	mm	inch	mm	B	L		
CLRU-0604-	3/8	9.52	0.039	1.00	1/4	6.35	0.039	1.00	19.00	39.00		
CLRU-0804-	1/2	12.70	0.049	1.24	1/4	6.35		1.00				
CLRU-0806-	1/2	12.70	0.049	1.24	3/8	9.52		1.00		42.90		
CLRU-1204-	3/4	19.05	0.065	1.65	1/4	6.35		1.00				
CLRU-1206-	3/4	19.05	0.065	1.65	3/8	9.52		1.00		44.5		
CLRU-1208-	3/4	19.05	0.065	1.65	1/2	12.70	0.049	1.24				
CLRU-1604-	1	25.40	0.065	1.65	1/4	6.35	0.039	1.00	44.5			
CLRU-1606-	1	25.40	0.065	1.65	3/8	9.52	1.00					
CLRU-1608-	1	25.40	0.065	1.65	1/2	12.70	0.049	1.24				
CLRU-1612-	1	25.40	0.065	1.65	3/4	19.05	0.065	1.65				

CLT Long Tee

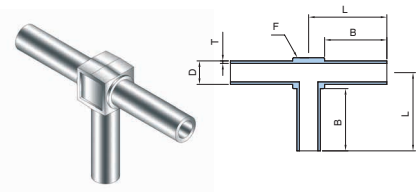

Part No.	Tube O.D. D		Tube W.T. T		Dimension (mm)			Body Cube
	inch	mm	inch	mm	B	L	F	
CLT-04-	1/4	6.35	0.039	1.00	19.00	20.00	25.00	9.00
CLT-06-	3/8	9.52		1.00			11.00	
CLT-08-	1/2	12.7	0.049	1.24		27.00	15.00	
CLT-12-	3/4	19.05	0.065	1.65		31.50	22.00	
CLT-16-	1	25.4	0.065	1.65		34.00	30.00	

Dimensions are for reference only and are subject to change without prior notice.

Dimensions are for reference only and are subject to change without prior notice.

Glands

CMGS

Micro Gland S

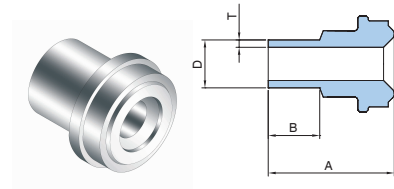

Part No.	UCR Size	Tube O.D. D		Tube W.T. T		Dimension (mm)	
	inch	inch	mm	inch	mm	A	B
CMGS-04-	1/4	1/4	6.35	0.039	1.00	15.30	6.35
CMGS-0804-	1/2	1/4	6.35		1.00		
CMGS-0806-	1/2	3/8	9.52		1.00	15.80	
CMGS-08-	1/2	1/2	12.70	0.049	1.24		

CMGL

Micro Gland L

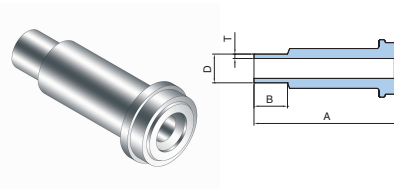

Part No.	UCR Size	Tube O.D. D		Tube W.T. T		Dimension (mm)	
	inch	inch	mm	inch	mm	A	B
CMGL-04-	1/4	1/4	6.35	0.039	1.00	30.50	6.35
CMGL-0804-	1/2	1/4	6.35		1.00		
CMGL-0806-	1/2	3/8	9.52		1.00	32.80	
CMGL-08-	1/2	1/2	12.70	0.049	1.24		

CSGS

Short Gland S

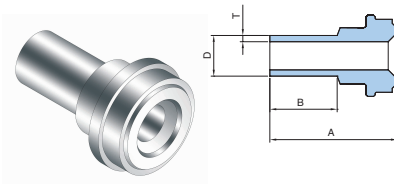

Part No.	UCR Size	Tube O.D. D		Tube W.T. T		Dimension (mm)	
	inch	inch	mm	inch	mm	A	B
CSGS-04-	1/4	1/4	6.35	0.039	1.00	18.95	10.00
CSGS-0804-	1/2	1/4	6.35		1.00		
CSGS-0806-	1/2	3/8	9.52		1.00	19.45	
CSGS-08-	1/2	1/2	12.70	0.049	1.24		

CSGL

Short Gland L

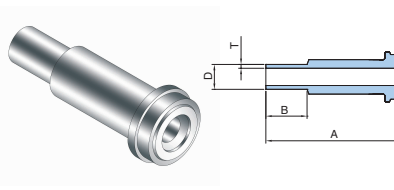

Part No.	UCR Size	Tube O.D. D		Tube W.T. T		Dimension (mm)	
	inch	inch	mm	inch	mm	A	B
CSGL-0402-	1/4	1/8	3.17	0.028	0.71	28.00	10.00
CSGL-04-	1/4	1/4	6.35	0.039	1.00	34.15	
CSGL-0804-	1/2	1/4	6.35		1.00		
CSGL-0806-	1/2	3/8	9.52		1.00	36.45	
CSGL-08-	1/2	1/2	12.70		0.049	1.24	

Dimensions are for reference only and are subject to change without prior notice.

CLGS

Long Gland S

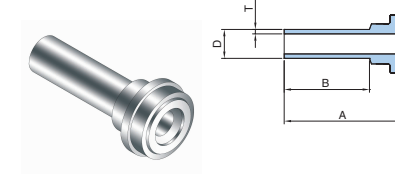

Part No.	UCR Size	Tube O.D. D		Tube W.T. T		Dimension (mm)	
	inch	inch	mm	inch	mm	A	B
CLGS-0402-	1/4	1/8	3.17	0.028	0.71	28.00	19.05
CLGS-04-	1/4	1/4	6.35	0.039	1.00		
CLGS-0804-	1/2	1/4	6.35		1.00		
CLGS-0806-	1/2	3/8	9.52		1.00	28.50	
CLGS-08-	1/2	1/2	12.70		0.049	1.24	
CLGS-12-	3/4	3/4	19.05	0.065	1.65	32.00	20.60
CLGS-16-	1	1	25.40	0.065	1.65	38.60	19.05

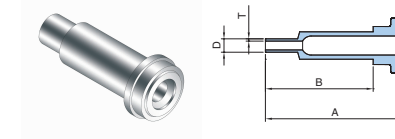

Part No.	UCR Size	Tube O.D. D		Tube W.T. T		Dimension (mm)	
	inch	inch	mm	inch	mm	A	B
CLGS-0402-33.5-	1/4	1/8	3.17	0.028	0.71	33.50	20.00

CLGL

Long Gland L

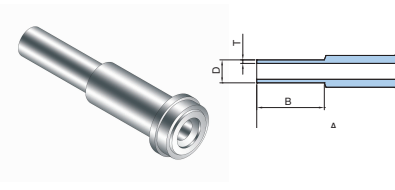

Part No.	UCR Size	Tube O.D. D		Tube W.T. T		Dimension (mm)	
	inch	inch	mm	inch	mm	A	B
CLGL-04-	1/4	1/4	6.35	0.039	1.00	43.20	19.05
CLGL-0804-	1/2	1/4	6.35		1.00		
CLGL-0806-	1/2	3/8	9.52		1.00	45.50	
CLGL-08-	1/2	1/2	12.70	0.049	1.24		
CLGL-12-	3/4	3/4	19.05	0.065	1.65	52.00	20.60
CLGL-16-	1	1	25.40	0.065	1.65	58.90	19.05

Dimensions are for reference only and are subject to change without prior notice.

CSGWS

Socket Weld
Short Gland

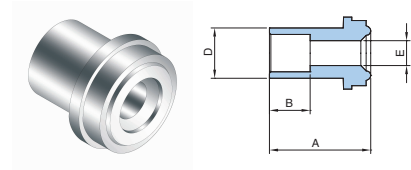

Part No.	UCR Size	Tube O.D. D		Tube W.T. T		Dimension (mm)		
	inch	inch	mm	inch	mm	A	B	E
CSGWS-04T-	1/4	1/4	6.35	0.039	1.00	12.70	7.10	4.35

CLGWS

Socket Weld
Long Gland

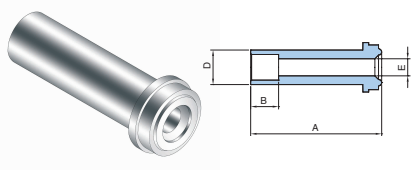

Part No.	UCR Size	Tube O.D. D		Tube W.T. T		Dimension (mm)		
	inch	inch	mm	inch	mm	A	B	E
CLGWS-04-	1/4	1/4	6.35	0.039	1.00	33.30	7.10	4.35
CLGWS-0806-	1/2	3/8	9.52		1.00	38.10	7.90	7.53
CLGWS-08-	1/2	1/2	12.70	0.049	1.24		9.60	10.22
CLGWS-12-	3/4	3/4	19.05	0.065	1.65	50.80	11.20	15.75
CLGWS-16-	1	1	25.40	0.065	1.65	56.40	15.70	22.10

CLGRWS

Reducing Socket Weld
Long Gland

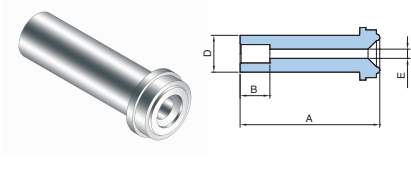

Part No.	UCR Size	Tube O.D. D		Tube W.T. T		Dimension (mm)		
	inch	inch	mm	inch	mm	A	B	E
CLGRWS-0402-	1/4	1/8	3.17	0.028	0.71	33.30	2.50	2.30
CLGRWS-0804-	1/2	1/4	6.35	0.039	1.00	38.10	7.10	4.35

CBG

Blind Gland

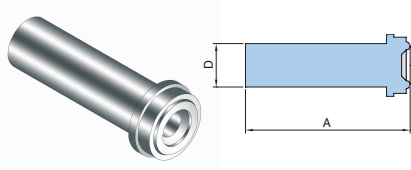

Part No.	UCR Size	Tube O.D. D		Dimension (mm)
	inch	inch	mm	A
CBG-04-	1/4	1/4	6.35	33.30
CBG-08-	1/2	1/2	12.70	38.10
CBG-12-	3/4	3/4	19.05	50.80
CBG-16-	1	1	25.40	50.40

Dimensions are for reference only and are subject to change without prior notice.

Caps, Plugs, Nuts & Gaskets

CCP

UCR Cap

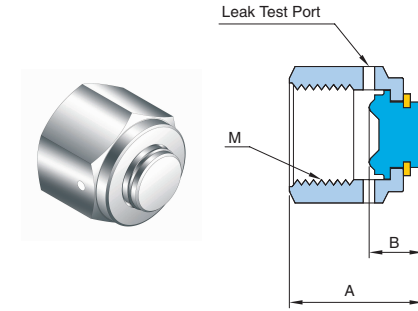

Part No.	UCR Size	Dimension (mm)			M
	inch	A	B	F	
CCP-04-	1/4	22.90	11.30	19.05	9/16-18UNF
CCP-08-	1/2	25.60	12.20	26.98	7/8-14UNF
CCP-12-	3/4	32.80	13.70	38.10	1 1/4-18UNF
CCP-16-	1	39.40	16.00	46.04	1 1/2-20UNF

CPG

UCR Plug

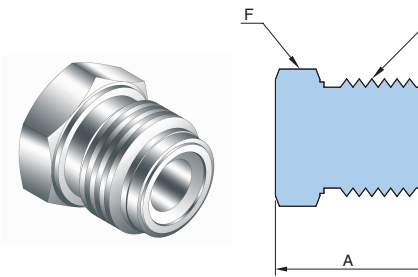

Part No.	UCR Size	Dimension (mm)		M
	inch	A	F	
CPG-04-	1/4	23.20	17.46	9/16-18UNF
CPG-08-	1/2	27.30	23.81	7/8-14UNF
CPG-12-	3/4	36.30	34.92	1 1/4-18UNF
CPG-16-	1	38.60	47.68	1 1/2-20UNF

CFN

UCR Female Nut

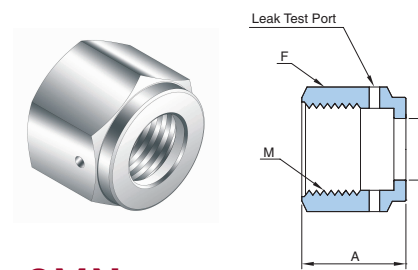

Part No.	UCR Size	Dimension (mm)			M
	inch	A	E	F	
CFN-04-	1/4	20.50	9.00	19.05	9/16-18UNF
CFN-08-	1/2	22.50	15.30	26.98	7/8-14UNF
CFN-12-	3/4	28.40	22.60	38.10	1 1/4-18UNF
CFN-16-	1	34.00	30.50	46.04	1 1/2-20UNF

CMN

UCR Male Nut

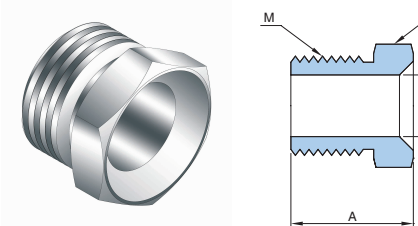

Part No.	UCR Size	Dimension (mm)			M
	inch	A	E	F	
CMN-04-	1/4	18.00	9.10	15.88	9/16-18UNF
CMN-08-	1/2	20.00	15.00	23.81	7/8-14UNF
CMN-12-	3/4	25.40	22.60	34.92	1 1/4-18UNF
CMN-16-	1	30.20	30.50	41.27	1 1/2-20UNF

Dimensions are for reference only and are subject to change without prior notice.

CGT

UCR Gasket

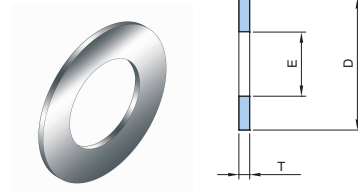

Part No.	UCR Size	Dimension (mm)		
	inch	E	D	T
CGT-04-	1/4	5.60	11.80	0.75
CGT-08-	1/2	11.00	19.30	
CGT-12-	3/4	17.00	28.10	
CGT-16-	1	22.60	34.80	

CGTR

UCR Gasket Retained

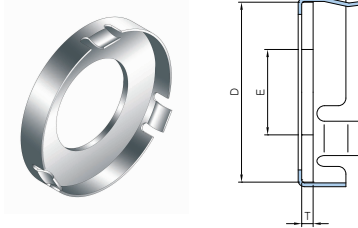

Part No.	UCR Size	Dimension (mm)		
	inch	E	D	T
CGTR-04-	1/4	5.60	11.80	0.75
CGTR-08-	1/2	11.00	19.30	
CGTR-12-	3/4	17.00	28.10	
CGTR-16-	1	22.60	34.80	

CGTB

UCR Gasket Blind

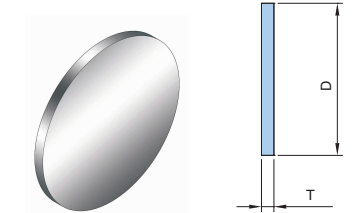

Part No.	UCR Size	Dimension (mm)	
	inch	D	T
CGTB-04-	1/4	11.80	0.75
CGTB-08-	1/2	19.30	
CGTB-12-	3/4	28.10	
CGTB-16-	1	34.80	

Retainer Color Coding

Easy identification of gasket materials before assembly or throughout the leak test port of Female Nut after assembly



316LSS

Nickel

Materials of Gaskets

Every gaskets are available with Nickel and 316LSS. To order, add the material designator to the end of part number.

Examples :

CGT-04-NI Gasket, 1/4", Nickel

CGTR-08-SL Retained Gasket, 1/2", 316LSS

Dimensions are for reference only and are subject to change without prior notice.

High Flow Components

CHG

HR Gland

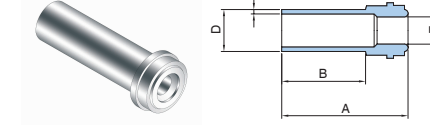

Part No.	UCR Size	Tube O.D.		Tube W.T.		Dimension (mm)		
	inch	inch	mm	inch	mm	A	B	E
CHG-0406B-	1/4	3/8	9.52	0.039	1.00	28.70	19.05	6.20
CHG-0406B-33.3-	1/4	3/8	9.52	0.039	1.00	33.30	28.50	6.20

CHA

HR Adapter

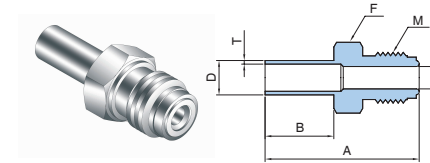

Part No.	UCR Size	Tube O.D.		Tube W.T.		Dimension (mm)				M
	inch	inch	mm	inch	mm	A	B	E	F	
CHA-0406-	1/4	3/8	9.52	0.039	1.00	42.70	19.05	6.35	17.46	9/16-18UNF

CHBA

HR Bulkhead Adapter

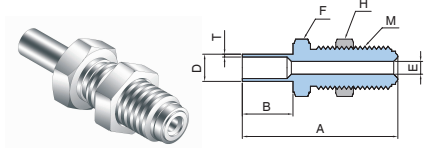

Part No.	UCR Size	Tube O.D.		Tube W.T.		Dimension (mm)					M	Panel Hole Size
	inch	inch	mm	inch	mm	A	B	E	F	H		
CHBA-0406-	1/4	3/8	9.52	0.039	1.00	59.80	19.05	6.30	19.05	19.05	9/16-18UNF	15.00

CHF

HR Female Nut

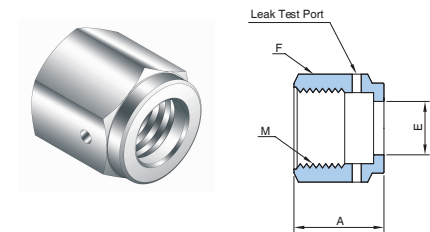

Part No.	UCR Size	Dimension (mm)			M
	inch	A	E	F	
CHF-04-	1/4	17.30	11.50	19.05	9/16-18UNF

CHMN

HR Male Nut

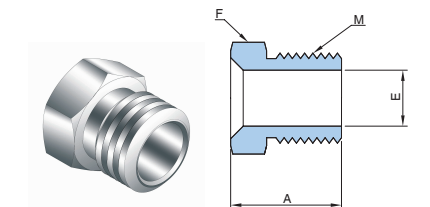

Part No.	UCR Size	Dimension (mm)			M
	inch	A	E	F	
CHMN-04-	1/4	18.00	9.90	15.88	9/16-18UNF

Dimensions are for reference only and are subject to change without prior notice.

UCR to UCR

CDMU

Double Male Union

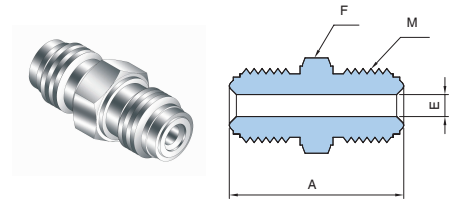

Part No.	UCR Size	Dimension (mm)			M
	inch	A	E	F	
CDMU-04-	1/4	39.40	4.57	15.87	9/16-18UNF
CDMU-08-	1/2	47.20	10.22	23.80	7/8-14UNF
CDMU-12-	3/4	62.00	15.70	33.33	1 1/4-18UNF
CDMU-16-	1	65.80	22.10	41.27	1 1/2-20UNF

CDMRU

Reducing Double Male Union

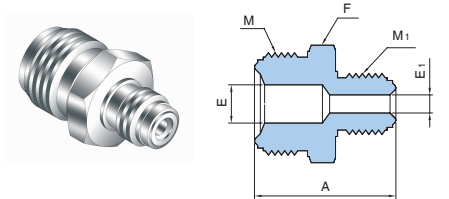

Part No.	UCR Size	UCR Size	Dimension (mm)				M	M ₁
	inch	inch	A	E	E ₁	F		
CDMRU-0804-	1/2	1/4	43.40	10.22	4.57	23.80	7/8-14UNF	9/16-18UNF

CBDMU

Bulkhead Double Male Union

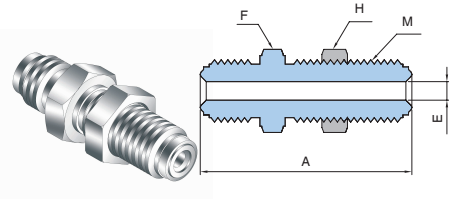

Part No.	UCR Size	Dimension (mm)					M	Panel Hole Size
	inch	A	B	E	F	H		
CBDMU-04-	1/4	56.60	33.70	4.57	19.05	19.05	9/16-18UNF	15.00
CBDMU-08-	1/2	65.30	37.60	10.22	26.98	26.98	7/8-14UNF	23.00

CEU

Union Elbow

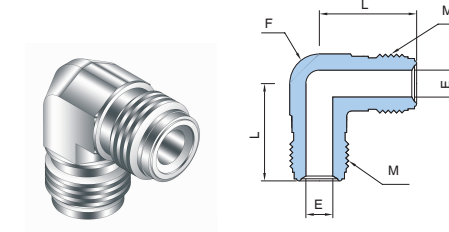

Part No.	UCR Size	Dimension (mm)			M
	inch	L	E	F	
CEU-04-	1/4	27.20	4.35	12.70	9/16-18UNF
CEU-08-	1/2	36.80	10.22	20.63	7/8-14UNF
CEU-12-	3/4	48.80	15.75	31.75	1 1/4-18UNF
CEU-16-	1	50.80	22.10	42.86	1 1/2-20UNF

Dimensions are for reference only and are subject to change without prior notice.

CUT

Union Tee

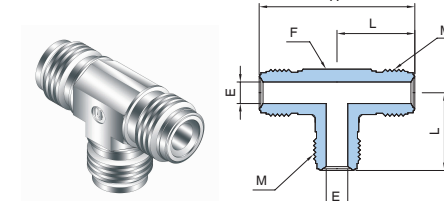

Part No.	UCR Size	Dimension (mm)				M
	inch	A	E	L	F	
CUT-04-	1/4	54.40	4.35	27.20	12.70	9/16-18UNF
CUT-08-	1/2	73.87	10.22	36.80	20.63	7/8-14UNF
CUT-12-	3/4	97.50	15.75	48.80	31.75	1 1/4-18UNF
CUT-16-	1	102.00	22.10	50.80	42.86	1 1/2-20UNF

CUC

Union Cross

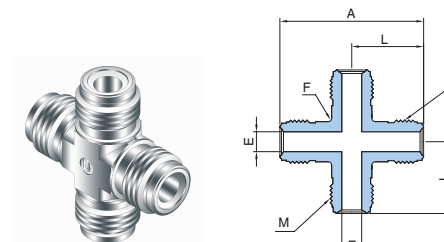

Part No.	UCR Size	Dimension (mm)				M
	inch	A	E	L	F	
CUC-04-	1/4	54.40	4.35	27.20	12.70	9/16-18UNF
CUC-08-	1/2	73.87	10.22	36.80	20.63	7/8-14UNF
CUC-12-	3/4	97.50	15.75	48.80	31.75	1 1/4-18UNF
CUC-16-	1	102.00	22.10	50.80	42.86	1 1/2-20UNF

CDFRU

Reducing Double Female Union

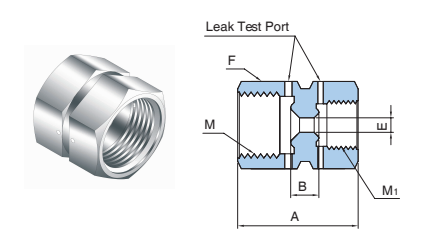

Part No.	UCR Size	UCR Size	Dimension (mm)				M	M ₁
	inch	inch	A	B	E	F		
CDFRU-0804-	1/2	1/4	34.60	6.00	4.35	26.98	7/8-14UNF	9/16-18UNF

CRA

Reducing Adapter

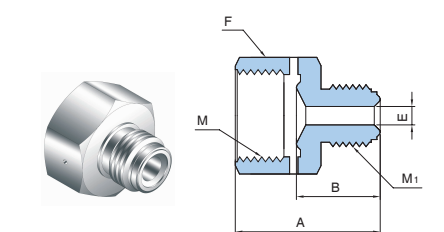

Part No.	UCR Size	UCR Size	Dimension (mm)				M (Female)	M ₁ (Male)
	inch	inch	A	B	E	F		
CRA-0804-	1/2	1/4	35.80	21.60	4.35	26.98	7/8-14UNF	9/16-18UNF

Dimensions are for reference only and are subject to change without prior notice.

CRB Reducing Bushing

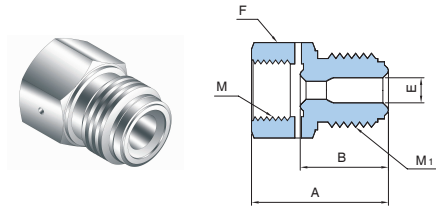

Part No.	UCR Size	UCR Size	Dimension (mm)				M (Female)	M ₁ (Male)
	inch	inch	A	B	E	F		
CRB-0804-	1/2	1/4	35.80	23.10	4.35	23.81	9/16-18UNF	7/8-14UNF

CC Coupling

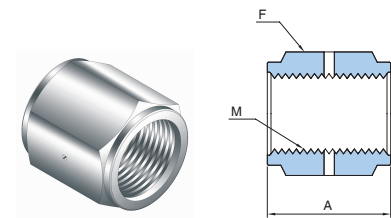

Part No.	UCR Size	Dimension (mm)		M (Female)
	inch	A	H	
CC-04-	1/4	30.20	19.05	9/16-18UNF
CC-08-	1/2	33.30	26.98	7/8-14UNF
CC-12-	3/4	42.70	38.10	1 1/4-18UNF
CC-16-	1	51.80	44.45	1 1/2-20UNF

UCR to TBW (Tube Butt Weld)

CAWB TBW Adapter

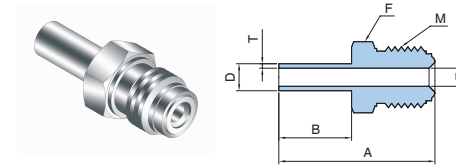

Part No.	UCR Size	Tube O.D. D	Tube W.T. T		Dimension (mm)				M (Male)	
	inch	inch	mm	inch	mm	A	B	E		H
CAWB-04-	1/4	1/4	6.35	0.039	1.00	42.65	19.05	4.35	15.88	9/16-18UNF
CAWB-0806-	1/2	3/8	9.52		1.00	46.70		10.22	23.81	7/8-14UNF
CAWB-08-	1/2	1/2	12.70	0.049	1.24	46.70	10.22	23.81	7/8-14UNF	

CBAWB Bulkhead TBW Adapter

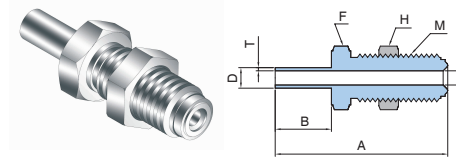

Part No.	UCR Size	Tube O.D. D	Tube W.T. T		Dimension (mm)				M (Male)	Panel Hole Size	
	inch	inch	mm	inch	mm	A	B	F			H
CBAWB-04-	1/2	1/4	6.35	0.039	1.00	59.85	19.05	19.05	19.05	9/16-18UNF	15.00
CBAWB-0804-	1/2	3/8	9.52		1.00	65.25		26.98	26.98	7/8-14UNF	23.00
CBAWB-08-	1/2	1/2	12.70	0.049	1.24	71.30	38.10	38.10	1 1/4-18UNF	32.00	

CULC UNILOK Connector

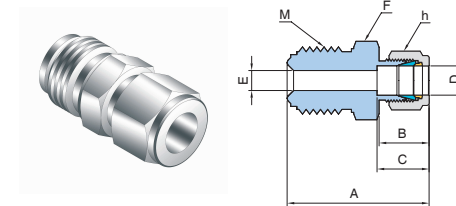

Part No.	UCR Size	Tube O.D. D	Dimension (mm)						M (Male)	
	inch	inch	mm	A	B	C	E	F		h
CULC-0402-	1/4	1/8	3.17	38.90	15.20	12.70	2.30	15.87	11.11	9/16-18UNF
CULC-04-	1/4	1/4	6.35	41.10	17.80	15.20	4.60	15.87	14.28	9/16-18UNF
CULC-0806-	1/2	3/8	9.52	46.70	19.30	16.80	7.10	23.81	17.46	7/8-14UNF
CULC-08-	1/2	1/2	12.70	49.50	21.80	22.90	10.20	23.81	22.22	7/8-14UNF

CBULC Bulkhead UNILOK Connector

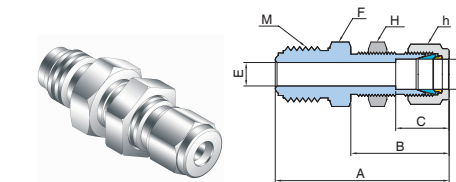

Part No.	UCR Size	Tube O.D. D	Dimension (mm)							M (Male)	Panel Hole Size	
	inch	inch	mm	A	B	C	E	F	H			h
CBULC-04	1/4	1/4	6.35	57.20	33.50	15.20	4.60	15.87	15.87	14.28	9/16-18UNF	11.50
CBULC-0806-	1/2	3/8	9.52	64.50	36.80	16.80	7.10	23.81	23.81	17.46	7/8-14UNF	14.70
CBULC-08-	1/2	1/2	12.70	69.60	41.90	22.90	10.20	23.81	23.81	22.22	7/8-14UNF	19.40

Dimensions are for reference only and are subject to change without prior notice.

Dimensions are for reference only and are subject to change without prior notice.

UCR to Thread

CUMC

Male Connector

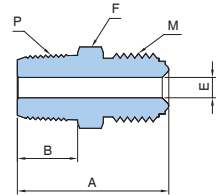

Part No.	UCR Size	Thread Size P-NPT	Dimension (mm)				M
	inch	inch	E	L	E	F	
CUMC-0402N-	1/4	1/8	33.30	9.60	4.35	15.90	9/16-18UNF
CUMC-0404N-	1/4	1/4	37.84	14.22	4.35	15.90	9/16-18UNF
CUMC-0804N-	1/2	1/4	41.87	14.22	10.22	23.80	7/8-14UNF
CUMC-0806N-	1/2	3/8	41.87	14.22	7.53	23.80	7/8-14UNF
CUMC-0808N-	1/2	1/2	46.74	19.05	10.22	23.80	7/8-14UNF
CUMC-1212N-	3/4	3/4	55.63	19.05	15.75	33.30	1 1/4-18UNF
CUMC-1616N-	1	1	62.74	23.88	22.10	42.40	1 1/2-20UNF

ISO7/1 Tapered Threads (PT) are available for all fractional sizes of CUMC. Add "R" as a suffix instead of "N"

CUME

Male Elbow

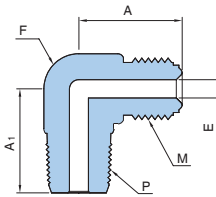

Part No.	UCR Size	Thread Size P-NPT	Dimension (mm)				M
	inch	inch	A	A ₁	E	F	
CUME-0404N-	1/4	1/4	27.18	27.18	4.35	15.95	9/16-18UNF
CUME-0806N-	1/2	3/8	36.83	32.00	10.22	23.80	9/16-18UNF
CUME-0808N-	1/2	1/2	36.83	36.83	10.22	23.80	7/8-14UNF
CUME-1212N-	3/4	3/4	48.80	43.50	15.75	33.30	7/8-14UNF

ISO7/1 Tapered Threads (PT) are available for all fractional sizes of CUME. Add "R" as a suffix instead of "N"

CUFC

Female Connector

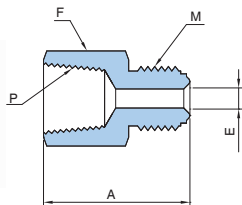

Part No.	UCR Size	Thread Size P-NPT	Dimension (mm)			M
	inch	inch	A	B	F	
CUFC-0402N-	1/4	1/8	35.80	4.35	15.90	9/16-18UNF
CUFC-0404N-	1/4	1/4	39.10	4.35	19.05	9/16-18UNF
CUFC-0806N-	1/2	3/8	44.70	7.53	23.81	7/8-14UNF
CUFC-0808N-	1/2	1/2	50.50	10.22	26.98	7/8-14UNF
CUFC-1212N-	3/4	3/4	59.90	15.75	33.33	1 1/4-18UNF
CUFC-1616N-	1	1	63.80	22.10	41.27	1 1/2-20UNF

ISO7/1 Tapered Threads (PT) are available for all fractional sizes of CUFC. Add "R" as a suffix instead of "N"

Dimensions are for reference only and are subject to change without prior notice.